

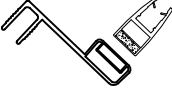



















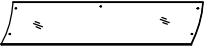

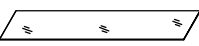
|   |  |   |   |  |   |   |  |   |
|---|--|---|---|--|---|---|--|---|
| A |         | 2 | J |         | 1 | S |         | 2 |
| B |  ST4X16 | 8 | K |  ST4X10 | 2 | T |         | 4 |
| C |         | 8 | L |         | 2 | U |  ST4X6  | 4 |
| D |  ST4X30 | 8 | M |  ST4X10 | 2 | V |         | 1 |
| E |         | 1 | N |         | 1 | W |  ST4X10 | 4 |
| F |         | 1 | O |         | 1 | X |         | 1 |
| G |         | 4 | P |         | 1 |   |  |   |
| H |       | 2 | Q |       | 1 |   |  |   |
| I |       | 2 | R |       | 2 |   |  |   |



Ø6, Ø2.8



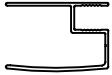
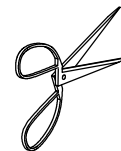
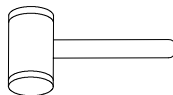
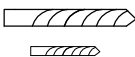
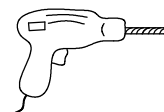
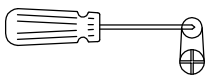
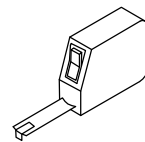
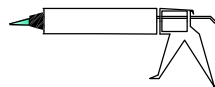
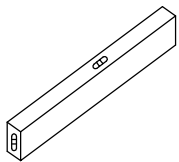
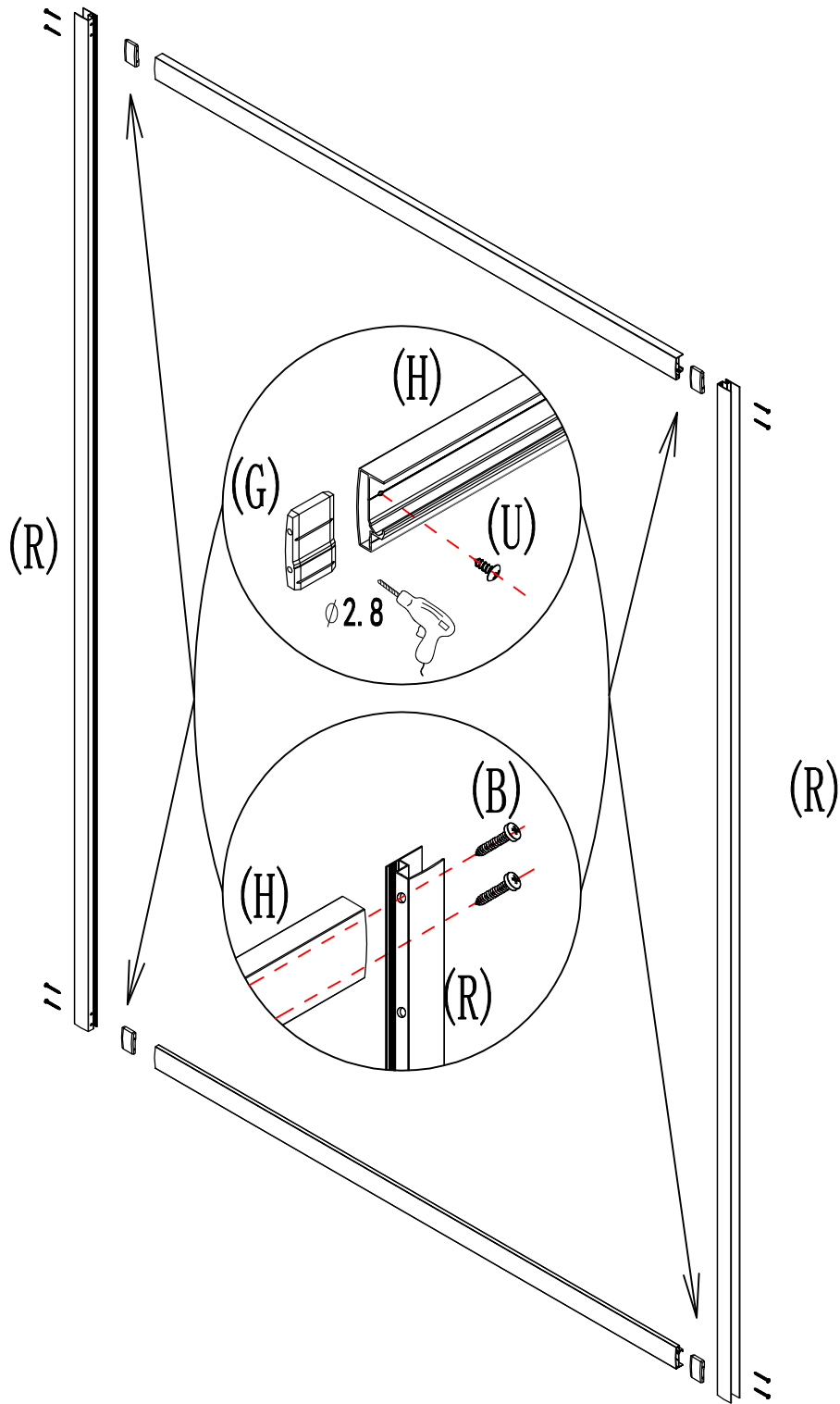
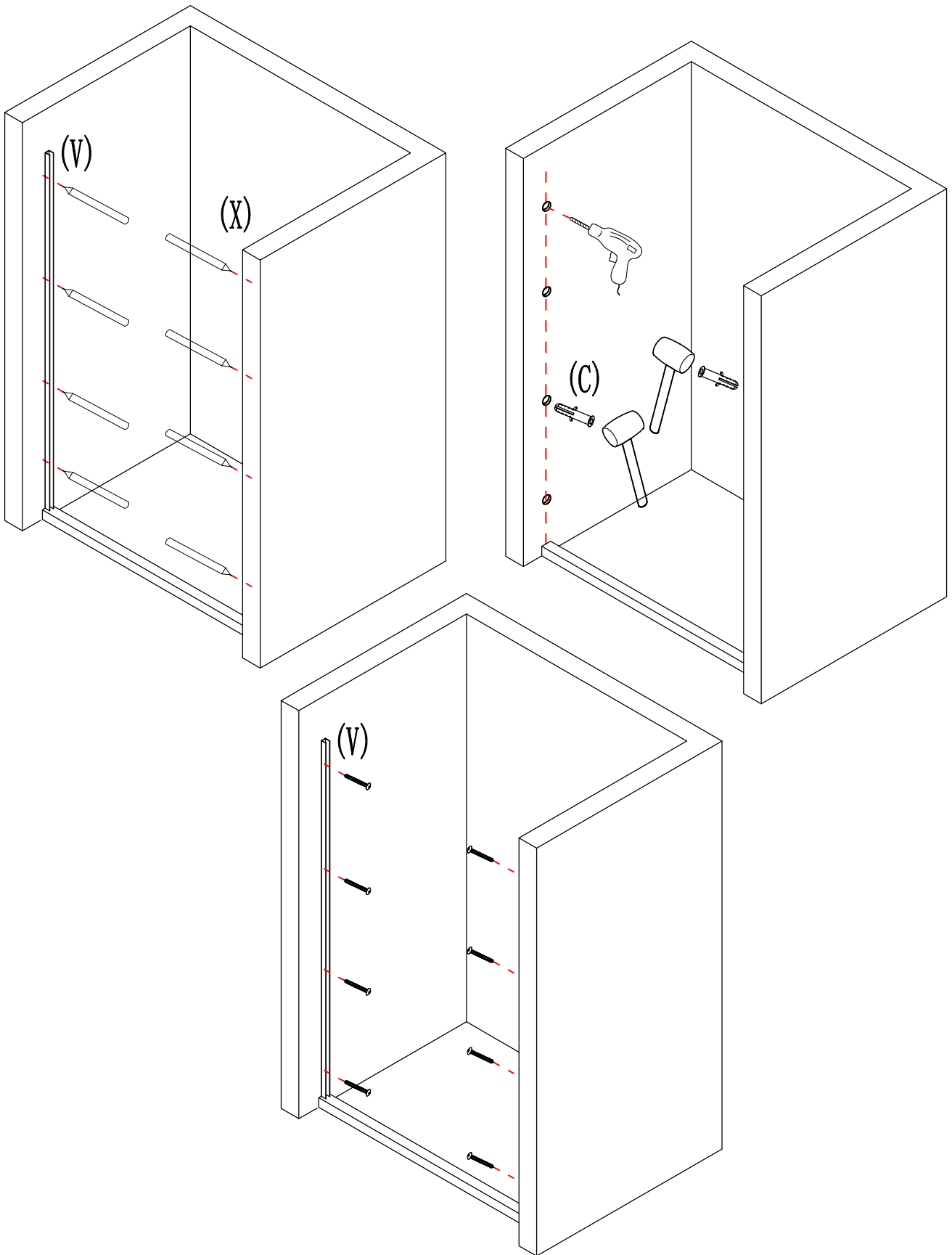

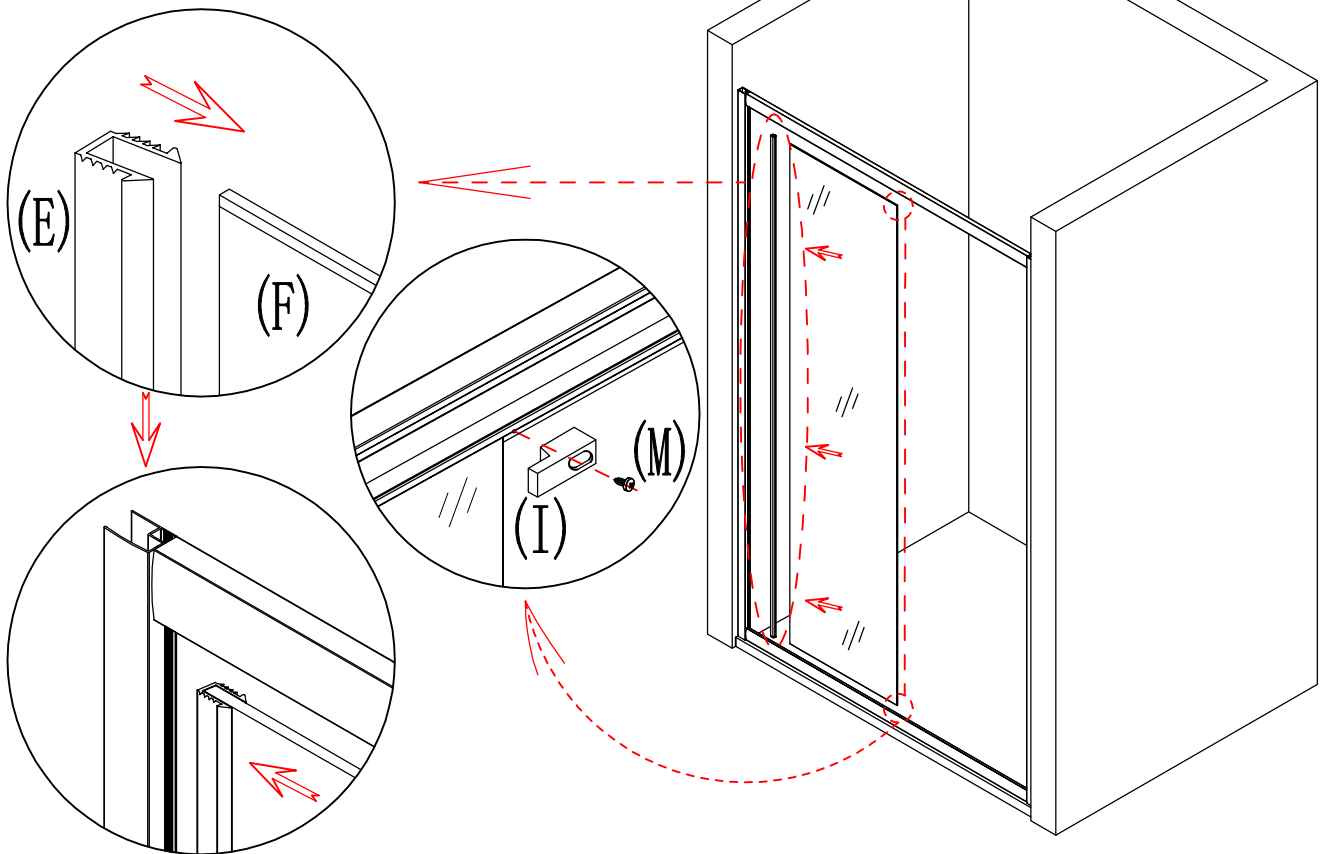
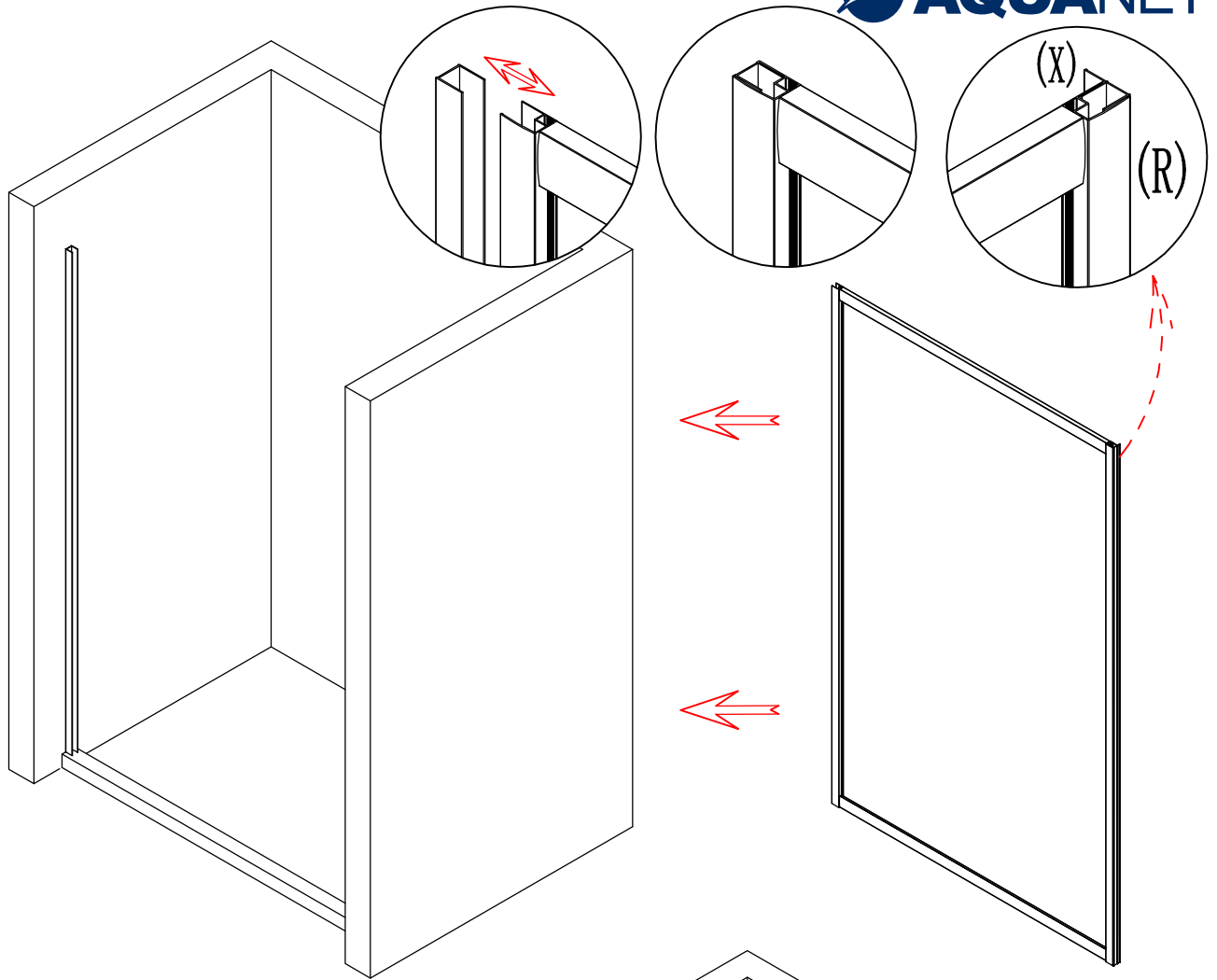

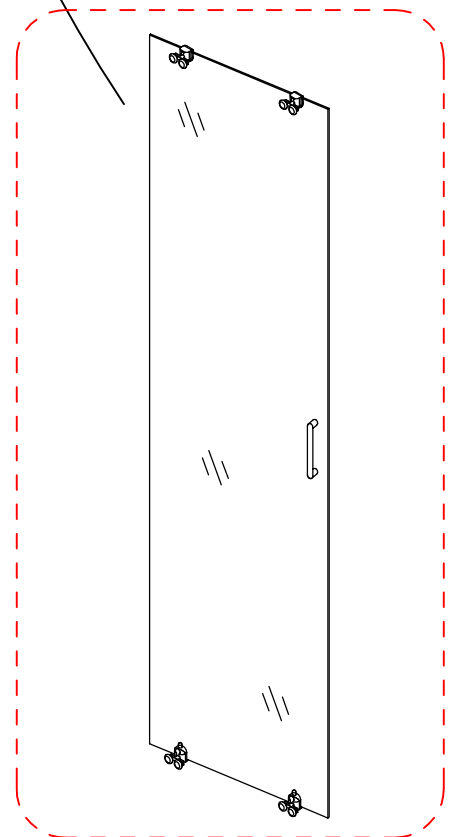
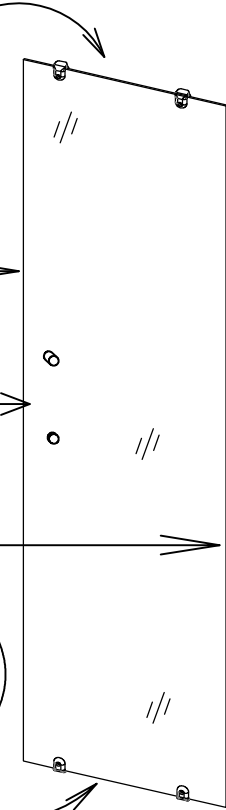
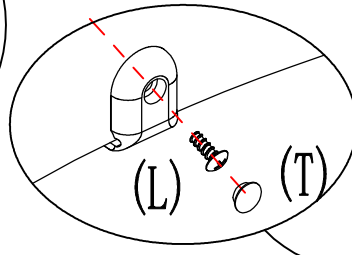
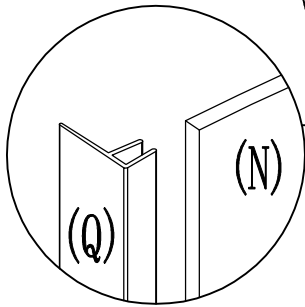
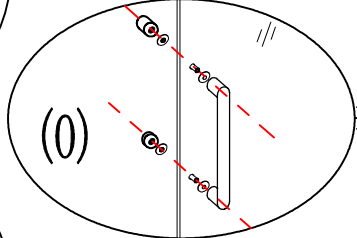
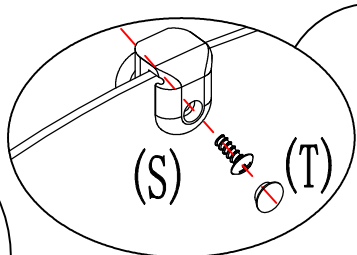
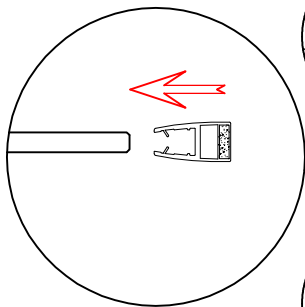
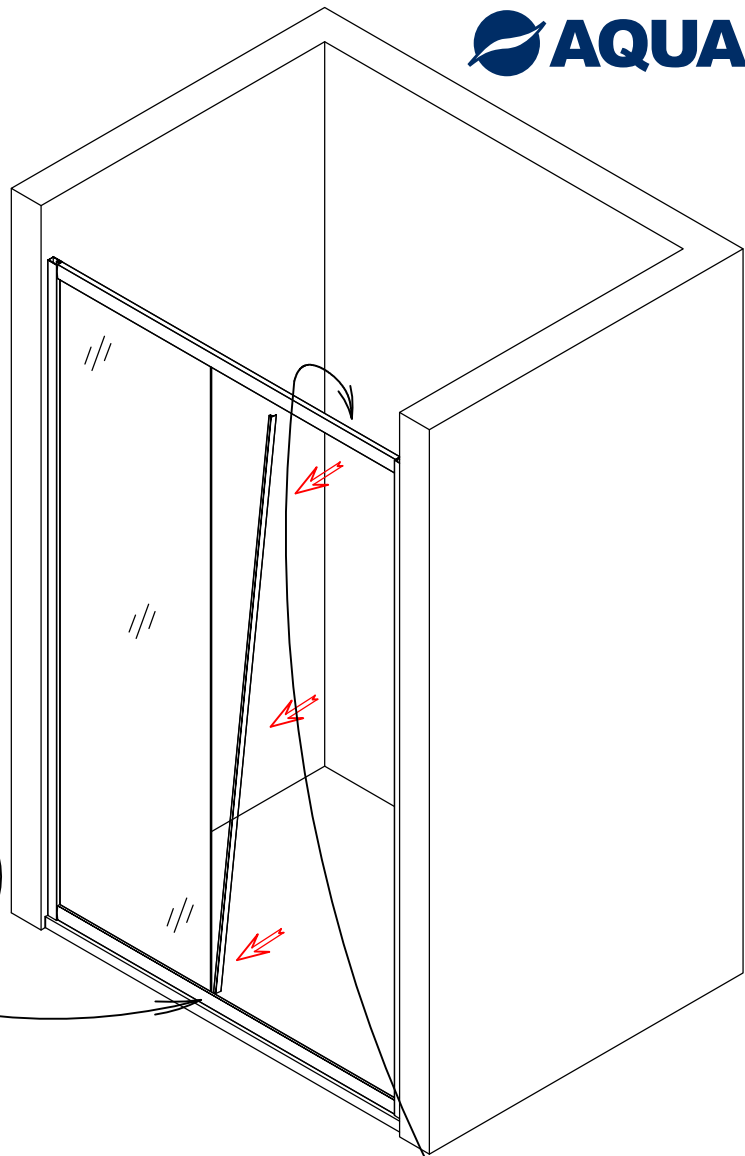
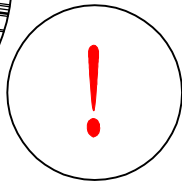
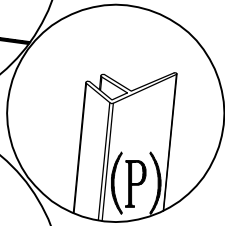
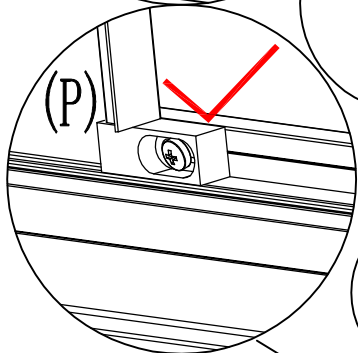
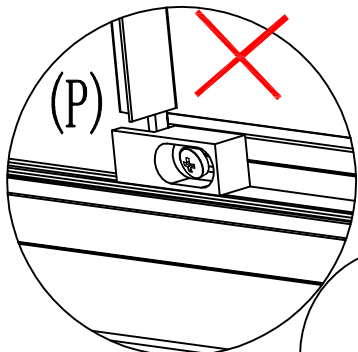

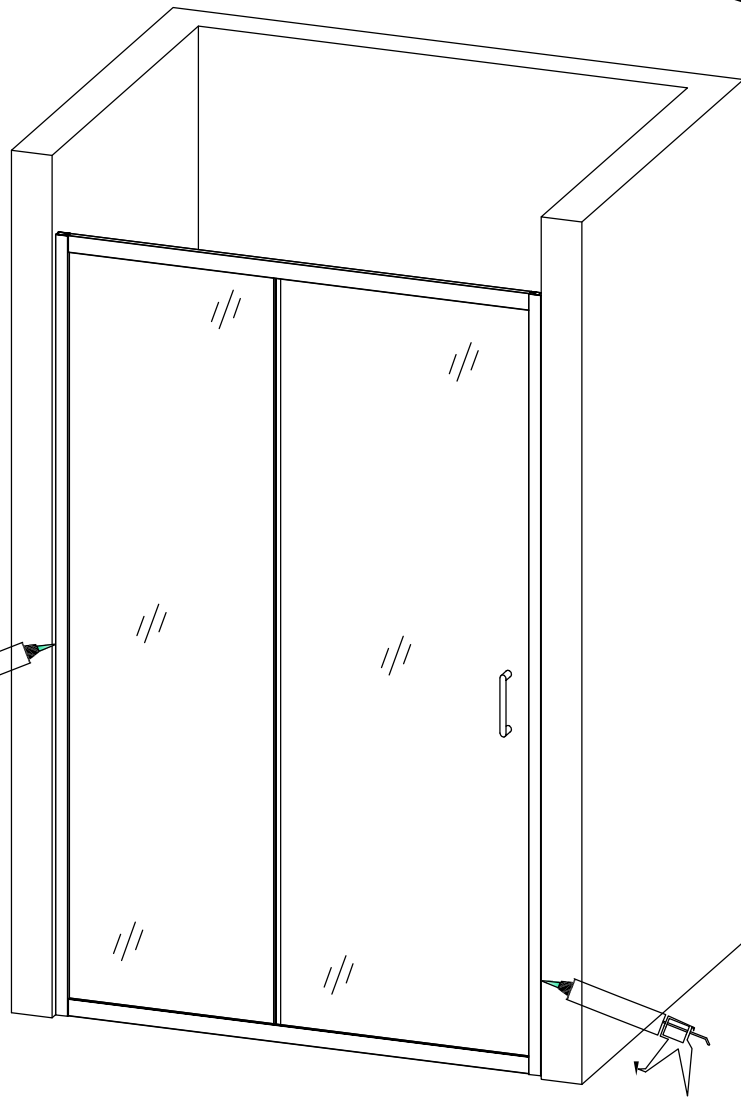
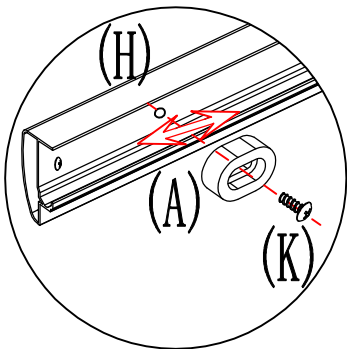
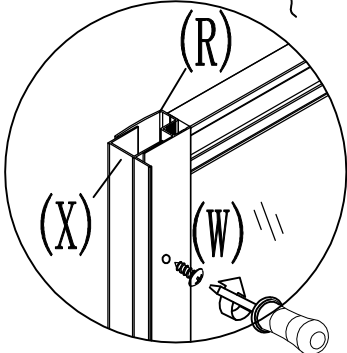
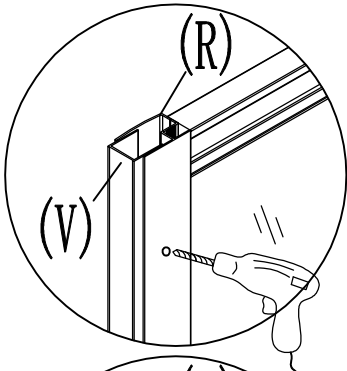
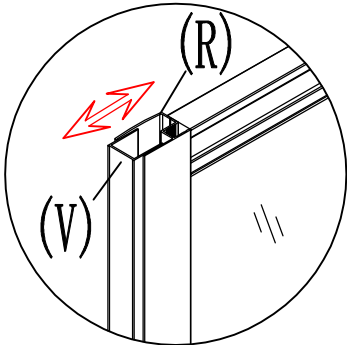
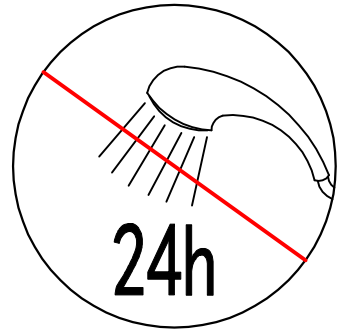
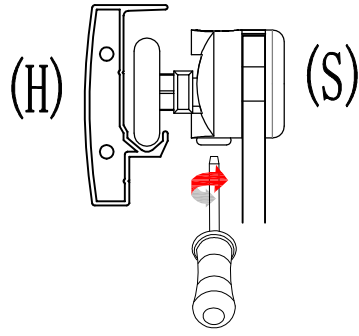





- |   |   |   |   |  |
|---|---|---|---|--|
|  |  |  |  |  |
| 4   | ST4X30 4  | ST4X10 2  | ST4X20 2  | 1  |

